

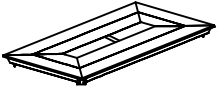

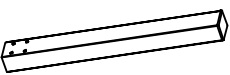



NO.	PHOTO	QTE
A		1PC
B		4PCS
C		16PCS
D		16PCS
E		2PCS
F		2PCS
G		1PC

### STEP 1



### STEP 2

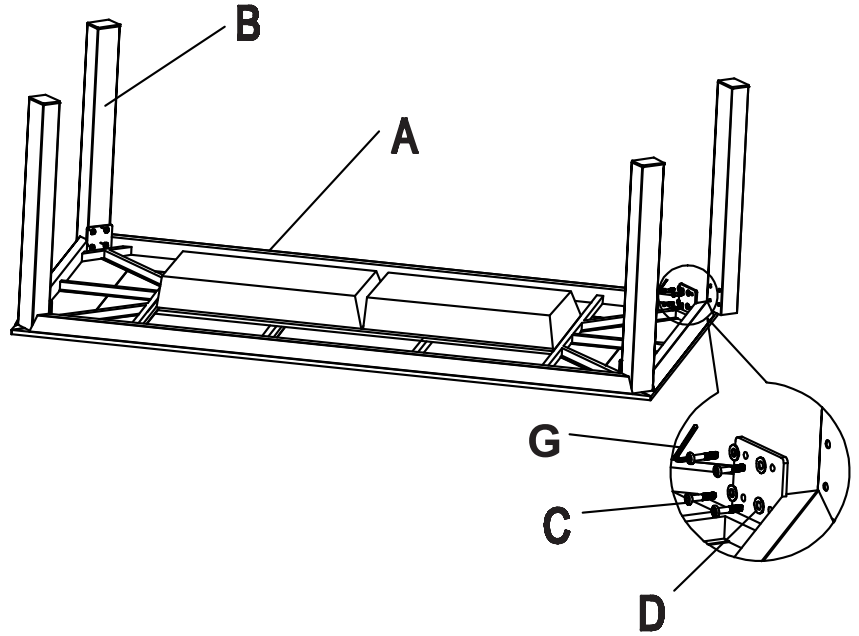